

Making Wooden Buckets

White cooperage, the Swiss way

by Drew Langsner

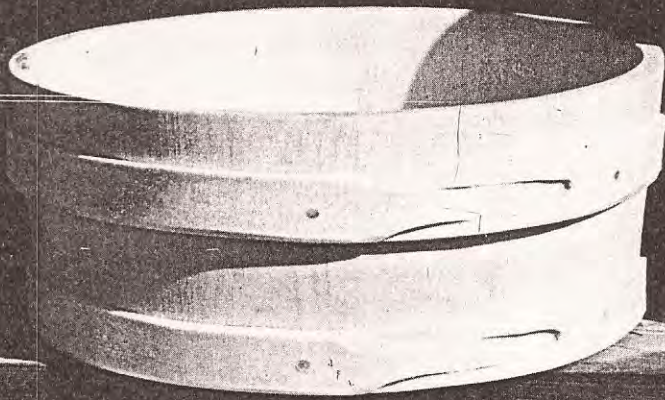

Swiss-style buckets of close-grained pine, with maple hoops. Traditionally used in small dairies, these liquid-tight containers are known as 'white' cooperage. The sculpted bucket, right, is carved from extra-thick staves after the staves have been glued together.

Coopered containers range in volume from huge wine vats to pint-size beer steins. Whatever their size, they are all basically tapered cylinders made of vertically arranged wooden staves with mitered edges. The staves are held tight by two or more hoops made from wood or metal. Bottoms consist of one or more boards which fit into a groove cut into the staves. Because of their cylindrical shape and the compression/tension relationship among staves, bottom and hooping, coopered containers are remarkably strong and durable.

As a trade and technique, cooperage may be divided into four overlapping areas: Wet cooperage is for holding liquids. Dry (or "slack") cooperage is for such less demanding needs as transporting or storing grains, fruits or nails. Of greater importance to woodworkers is the distinction between single-bottom and double-bottom cooperage. Double-bottom containers have bowed staves whose mitered edges are curved. Whiskey barrels are typical. In single-bottom cooperage—called "white cooperage" because the buckets are traditionally used to hold milk in small dairies—the staves are straight, as are the mitered edges.

The methods for single-bottom cooperage described in this article were taught to me by Rudolf Kohler, an 83-year-old cooper who lives and works in the Swiss Alps. I met Kohler in 1972, while I was searching for a traditional Swiss milking bucket to purchase as a souvenir. I'd not done much woodworking, but I became so fascinated with his work (and his beautiful shop) that I asked if it would be possible to study with him. He agreed and we managed well, even though I speak little German and Kohler knows no English; we put a great deal of positive energy into the relationship. Ten weeks later I wasn't a cooper, but I had become a woodworm. In 1980 I returned to Switzerland and worked with

Ruedi Kohler again, this time for three fast-moving, hard-learning weeks.

Cooperage in the Swiss Alps was traditionally a winter trade practiced by farmers who were occupied with outdoor work from spring to fall. When Kohler was 22, having practiced alpine farming and cheesemaking with his father, he paid an old cooper fifty Swiss francs for four months of winter training. At the time (1923) the wage for a day's work was three francs. The next winter Kohler returned for another session. This time his usefulness earned back the fifty francs, and he was presented with a set of coopers' tools, which he still uses. Kohler says that when he got into cooperage the craft was in its decline. New factory-made metal containers were cheaper than coopers' woodenware, and modern health regulations gradually prohibited using old dairy vessels except high in the Alps. World War II was a good time for coopers, because metal was scarce. But after the war cheap plastics were introduced, and cooperage almost died out. During the last 15 years, interest in traditional crafts has renewed the demand for woodenware. In 1967 Kohler retired from farm-

Types of cooperage



Single-bottom (white) cooperage uses straight staves with straight edges.

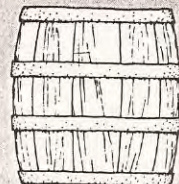

Double-bottom cooperage requires bowed staves, curved stave edges, and a minimum of four hoops.

ing and cheesemaking to become a full-time cooper. He still makes a few coopered vessels for farm use, but the greater part of his output goes to the tourist trade: milk buckets, bowls and butter churns that will never be put to work.

Cooperage techniques are closely related to those of many other traditional woodcrafts. Most of the work is done at a shaving horse, although a workbench with a vise and bench dogs is also useful. Many cooperage tools are shared by other crafts—hewing hatchets, froes, carving knives, drawknives, spokeshaves, planes, saws, drills, etc. Coopers also use several specialized tools—curved (hollowing) drawknives, convex-soled planes, and a device called a *croze*, which cuts a groove for the bottom board inside the assembled staves. I'll discuss each as it comes to hand when making a typical, single-bottom, staved container, 220mm ($8\frac{5}{8}$ in.) in diameter and 120mm ($4\frac{3}{4}$ in.) high.

Wood selection—Many woods can be used for cooperage, but there are definite qualities that all coopers look for. The wood must be straight-grained and must work easily with hand tools. Cooperage requires well-seasoned wood, because shrinking staves leak and loosen the hoops. Double-bottom cooperage requires wood that bends easily; the best is white oak. For single-bottom cooperage, the favored wood in Switzerland is arve (*Pinus cembra*), known in English as Swiss stone pine. It is a slow-growing conifer found at altitudes generally above 3,300 ft. Arve growth rings average about 1mm ($\frac{1}{32}$ in.) per year. The fibers are extremely small, and the wood works easily, even across end grain and through knots. Arve does grow in the United States (it's planted as an ornamental), but any straight-grained softwood will do: pine, cedar, redwood, Douglas fir, Linden (basswood) can also be used. One of the appeals of cooperage is that the wood is readily available, and you need only a few board feet to make a bucket.

Traditionally, coopers buy wood as bucked logs, either round or split. A neighbor tells Kohler about some pine firewood of extra-fine quality, or a local sawmill puts aside an arve log. Kohler used to begin with a crosscut saw, but today he bucks out sections with a chainsaw, working around major knots, sawing suitable stave lengths. Staves for our 120mm high bowl are initially cut 150mm (6 in.) long. These rounds are then radially split into pie-shaped billets, which are air-seasoned in a drafty hayloft for at least a year.

Kohler sometimes buys wood that has been plain-sawn into thick, unedged planks. Sawmill edging often wastes much wood. The advantage of lumber is that it is easy to handle. The disadvantage is that some staves will not be quarter-grained, which is never the case with split-out stock. After air-seasoning, the wood is roughed into stave blanks—split along a radial plane using a small froe and a maul. Stave width varies. For our small container, widths can range from 35mm ($1\frac{3}{8}$ in.) to 80mm (3 in.). Kohler uses a broad hatchet for trimming and roughly tapering the sides, perhaps 3mm to 6mm ($\frac{3}{16}$ in.) wider at the top than at the bottom. This produces a taper in the finished bucket such that the diameter of the bottom is about 10% less than that of the top.

Kohler next stacks the blanks against a south-facing outdoor wall for further air-drying. Then a few days before he needs them, he takes the staves indoors for a final drying on a

rack above the stove. He often groups stave blanks in bunches according to length, for single projects. At this stage the aggregate width of the staves should be about four times the bowl's diameter—in this case about 880mm (35 in.).

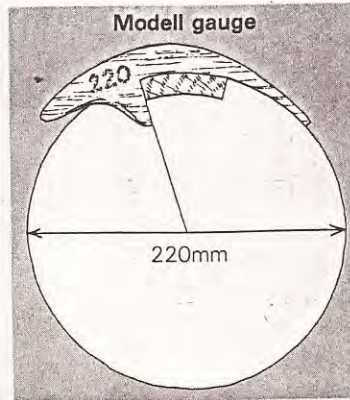

Shaping the staves—Swiss coopers find the correct edge angle of a stave with a simple gauge called a *modell*. The modell is a thin crescent-shaped piece of wood whose inner contour matches the exterior curve of the container. The perpendicular edge guide at one end of the modell represents the radius line of the curve.

Staves are shaped at a shaving horse, using a flat drawknife, a hollowing drawknife, a long jointer plane and an appropriate modell. Shaping

begins with drawknife work on the exterior face. Hold the modell across the top end of the blank to gauge the curvature, then with the blank in the shaving horse, shave the top third of the stave to fit the modell. You could pencil in the shape on the end grain, but Kohler just judges by eye. The first cuts should be light, to verify grain direction and irregularities. Block out the curve from the sides toward the center, keeping the stave as thick as possible. Turn the blank end for end and drawknife the rest of the outside face. The curve for the bottom end is gauged by eye to match that of the top end. The modell is not used at the bottom end because stave taper results in a tighter curve there. Fair the whole outside face. If necessary, use the drawknife in reverse, as a push tool, to handle grain that runs into the wood. Or reposition the stave in the shaving horse, to get the most from your pull stroke. Then turn the stave over.

Rough out the inside face with a hollowing drawknife. This is a deeply curved coopers' drawknife with an exterior bevel. Shave from both ends, to approximately 18mm ($\frac{11}{16}$ -in.) thickness. Do not attempt to cut thinner walls at this stage. If you don't have a hollowing drawknife, you can use either a scorp or a narrow inshave ground with an outside bevel. Or you can reshape (and retemper) a flat drawknife to an appropriate curvature, about 35mm ($1\frac{3}{8}$ -in.) depth across a circular arc that spans about 120mm ($4\frac{3}{4}$ in.). Another method (which Kohler uses for the inside of his oval milking buckets) is to dog individual staves to the workbench and hollow them with a convex-soled plane.

Edge angles are roughed out with a flat drawknife and the modell, which is always gauged at the upper rim. To hold the stave and have tool access along the full length of the edge, Kohler sets one end against a rabbet cut across the near end of the work ledge on his shaving horse. He holds the other end tight against a breast bib, a small flat board that hangs by a string around his neck. Stave edges must be flat, not twisted or curved. Any container has to be tapered so that the hoops can be driven tight, but more than an 8mm ($\frac{5}{16}$ -in.) taper for a 150mm (6-in.) long stave results in a container with too much taper, which won't hold its hoops.

Stave edges are finished with a jointer plane set upside down on the edge of the shaving horse, or secured in a vise. Run the stave over the plane, checking the angle between passes. For safety, grip the staves well above the plane sole, and spit on your fingertips to increase your hold. Besides the

correct angle, check for flatness. Hold pairs of staves side by side and look for uniform contact. Try wiggling them back and forth, making sure they don't wobble or roll.

Once the staves are jointed, lay them out side by side in a flat shallow arc to check for correct circumference (3.14 times intended diameter). The proper length, measured with a tape or a folding rule, which can follow the arc, should be the circumference you are aiming for, plus or minus 2%. If the series is too long, drawknife and plane one or more staves down to size. If too short, substitute a slightly larger stave.

Test assembly—Two wooden hoops will hold the completed container together. To position the staves for setting the hoops, Kohler drills mating holes and inserts small hardwood pegs into the sides of each stave. The pegged staves won't shift while the hoops are hammered tight.

Two temporary metal hoops are used in an initial test assembly, and to hold the staves in place for further shaping before the wooden hoops are fitted. Kohler makes his own metal hoops (see drawing, below right), and keeps a large collection of them in various diameters. To test-assemble, peg the staves together and place the cylinder on a workbench, bottom rim facing up. Fit the larger metal hoop onto the assembled staves first, and drive it tightly in place with a square-headed hammer or a coopers' hoop driver. A hoop driver looks like a blacksmiths' hammer with a notch ground along the peening edge. I made one by taking a small rock-climbing hammer and filing a groove into the face of its pick end. Set the groove over the hoop edge and hit the head of the driver with a second hammer. Work round and round until the hoop stops moving downward. The correct test-fit should be about one-fourth from the top rim of the container. When the first hoop is in position, fit the second, smaller hoop.

Although the staves are pegged, they can pivot in and out on those pegs. If a stave protrudes, hammer it in—but place a second hammer inside to dampen the blows, and vice versa—until you have averaged out the differences.

Check the container for roundness by measuring across the upper rim from two perpendicular locations. You can live with a discrepancy up to 5mm ($\frac{3}{16}$ in.). Look for openings between staves. If you find any, knock off the temporary hoop and check all edge angles against the modell. Reassemble. If there are still spaces on the inside, disassemble and plane one stave narrower. If gaps show on the outside, remove a stave (save it for your next container) and substitute a new one that's wider. This is your last chance to be sure that the staves fit together perfectly.

Dressing the assembled staves—Once you have the stave edges flush, you can dress the rims and the interior surface. Slightly moisten the end grain of the upper rim with a wet sponge, to soften the wood. Then plane the rim flat. A block plane works nicely. Check by eye or by placing the container upside down on a flat surface.

The lower rim of the assembled staves generally requires sawing before planing. Pencil a series of marks measuring from the (now flat) upper rim, in this case at 120mm ($4\frac{3}{4}$ in.). Set the container on its side and begin a shallow sawcut aimed from one pencil mark to the next. Kohler uses a small backsaw. Make a series of shallow passes around the container. For a flat cut, hold the saw parallel to the plane of the rim, not perpendicular to the side of the staves. With the

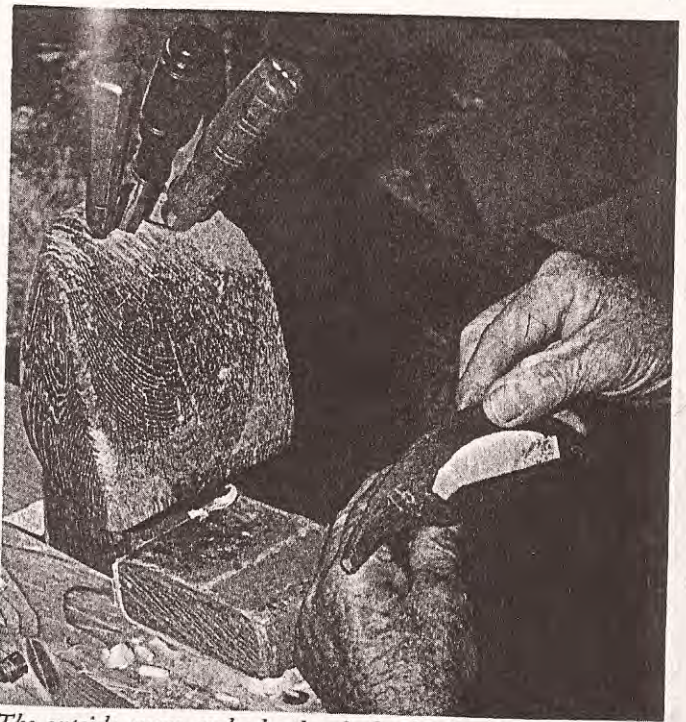

The outside curve and edge bevel of a bucket stave are checked with a gauge called a modell, drawn on facing page.



To shave short staves, cooper Ruedi Kohler supports one end of the blank in a rabbet on the front of his shaving-horse ledge, the other against a wooden bib.

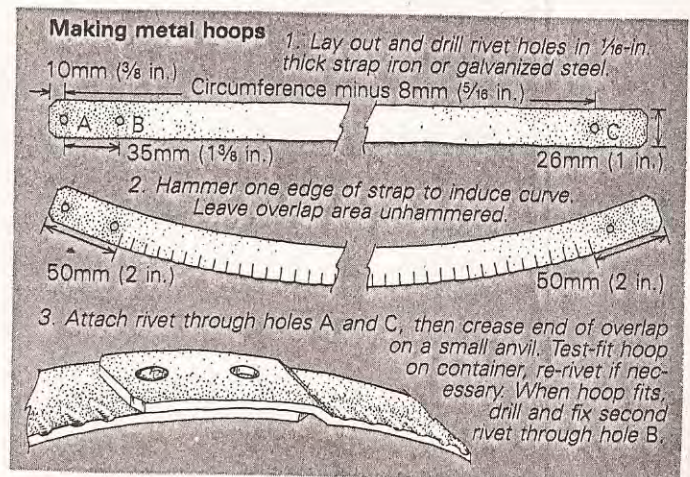

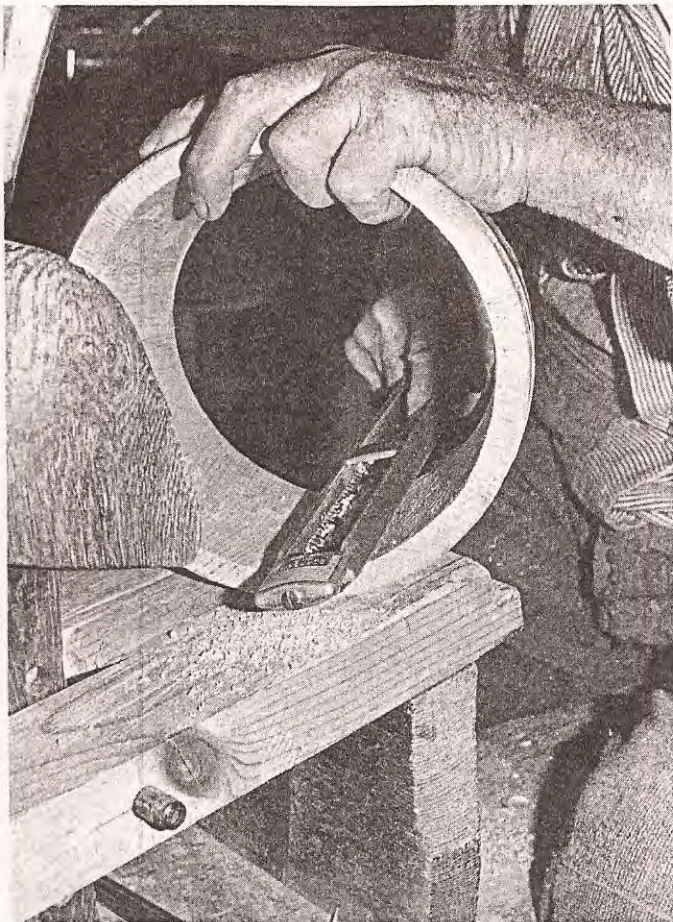

The staves are test-assembled and temporarily held in place with two metal hoops, so that the inside of the cylinder can be smoothed either with a convex-sole plane, as on the front cover, or with a Surform, above.

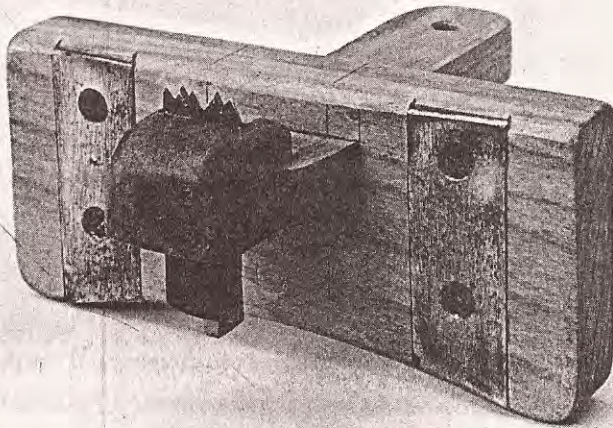

This croze is like a marking gauge with teeth. Instead of merely scribing the groove for the bottom, it cuts it directly into the assembled staves.

Shaping bottom board

1. Use a marking gauge to scribe the edge of the bottom board, and drawknife to this shape.



2. Use a slotted hardwood stick (called a fümel) to compress the edge to 4.5mm.

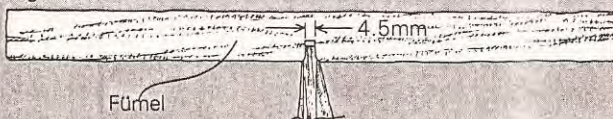

waste sawn away, plane the lower rim smooth.

At this point the staves are still of various thicknesses. To indicate their dressed thickness, bevel the rims inside and out, leaving the upper rim 15mm ($\frac{3}{8}$ in.) thick and the lower rim 17mm ($\frac{11}{16}$ in.) thick, to accommodate the groove for the bottom of the container. For the outside bevel, use a spokeshave held about 30° from the staves and produce a rim line as close to a circle as possible. Gauge the proper thickness and bevel the inside, using a sharp carving knife, held point down in your fist like a dagger.

Some white coopers dress the inside with a scorp, but Kohler uses small wooden planes with convex soles and irons. He planes along the length of the staves, first from the upper rim, then from the lower, until the inside surface is worked down to the rim guidelines. Difficult grain can be shaped with a convex Surform. Sand the inside with 80-grit, then 120-grit paper, working across the grain. The outside of the container will be dressed later.

The bottom—Kohler's croze, the tool that cuts the bottom groove in the assembled staves, resembles an enlarged marking gauge with a row of coarse teeth in place of the scriber (photo, below left). This cutter is held by a setscrew or a wedge in the sliding arm. The cutter's teeth are filed much like coarse crosscut-saw teeth, having 5 points to the inch. Kohler made his from an old plane iron. The groove can be cut in a number of other ways, including scribing the edges with a marking gauge and excavating it with a chisel.

On our container, the groove is 13mm ($\frac{1}{2}$ in.) above the lower rim, 5mm ($\frac{3}{16}$ in.) wide and 5mm deep. Set the assembled staves bottom up on the shaving-horse bench, secure between your thighs and against a block between the container and the upright supporting the shaving-horse work ledge. Be sure to hold the croze flat against the bottom rim. Press down hard to avoid chatter (and scratching the dressed staves) and take a series of shallow passes around the rim. The 5mm width of the groove requires resetting the distance between cutter and fence for a second round of passes.

Bottoms can be split from a wide straight-grained billet, taken from a clear sawn board, or glued up from narrower stock. The bottom wood is planed smooth on one side, scribed with a marking gauge to 18mm ($\frac{11}{16}$ in.) thick and planed to thickness.

You can find the radius for the bottom with straight-leg dividers. Open them to the approximate radius, judged by eye. Place one leg in the bottom of the groove and walk the dividers around the groove. By trial and error, readjust the dividers until you can walk off six equal divisions. The dividers are now set for the exact radius of the bottom.

Scribe the circumference on one face of the bottom and saw it out just outside the scribed line. Put the bottom in a vise, and spokeshave the rim to just inside the scribed line, rotating the wood in order to spokeshave with the grain. The bottom should be 0.5mm (0.02 in.) undersize.

With your marking gauge, scribe two lines 5.5mm ($\frac{1}{4}$ in.) apart on the edge of the bottom board, and then drawknife the board to the shape shown in the drawing at left. With the board still in the vise, use a hardwood stick with a 4.5mm ($\frac{3}{16}$ -in.) slot and compress the rim to 4.5mm thickness. Then sand the bottom board across the grain.

With the bottom shaped, you are ready to glue up. Knock off the metal hoops and disassemble the staves, laying them

on the workbench in order. Spread a thin coat of white glue on both edges of each stave. Glue is used so that the exterior can be dressed with the hoops removed. Do not use yellow glue. It sets too fast and complicates knocking the staves apart again if you run into trouble fitting the bottom. Re-assemble the staves with glue and pegs, and lower the bottom board (chamfered edge down) into the container from the top. Spread the lower rim until the bottom board snaps into its groove. Hold the staves in place with a loose-fitting, temporary upper hoop. Tap the staves around the bottom, replace the lower metal hoop, and tighten it with hammer and hoop driver. Hammer the staves in or out as necessary. Then tighten the upper hoop. Allow the glue to set at least one hour before you remove the metal hooping, so you can spokeshave the exterior of the staves to the beveled upper and lower edges. Sand the outside of the container.

Wooden hoops—The most distinctive feature of Swiss milk buckets is their beautiful wooden hoops. The design is a refined variation of the so-called arrow-lock pattern. Hoops can be made from maple, walnut, oak, even pine limbs. Traditionally, hooping stock comes from the trunk of a choice young maple, 120mm (4¾ in.) to 200mm (8 in.) in diameter at the butt. A tree that is growing in an open area is preferred because its limbs grow outward, perpendicular to the stem, yielding minimal grain deformity around knots. In thick woods, tree limbs reach up to the light, causing irregular stem grain.

Buck the bole to a length at least 200mm longer than the circumference you will need. The bottom hoop will fit flush with the container's bottom, and the top hoop will be about a hoop's width below the rim. Hoop length includes an overlap of some 160mm (6¾ in.), plus about 50mm (2 in.) for waste and end-cuts. Each bole length will yield 20 to 40 hoop blanks, and it may be possible to take two clear lengths from a single tree. Seal the end grain, and split the bole in half and then into eighths as wood is needed. Green wood is easiest to work and to bend, but air-dried wood can be used. Maple splits easily, but its grain is rarely straight, so bandsaw two radial strips 8mm to 10mm (about ⅜ in.) thick, and 30mm to 35mm (about 1⅜ in.) wide; the growth rings will cross the thickness of the strips. Blank from ring-porous hardwoods can be split to size. Drawknife the bark side to a smooth and straight, or slightly bowed, edge. You will have to support the hoop wood on an extension stick sandwiched between shaving-horse ledge and jaw.

Next, decide which will be the outside face of the hoop. This can be either side of the blank, but the wood often takes a natural bow. Drawknife the outside face smooth, then scribe a line 26mm (1 in.) from the dressed edge and drawknife the blank to width.

To fit the tapering shape of the container, the hoop in section must be thicker at the bottom than at the top. Mark and then drawknife the hoop 7mm (¼ in.) thick at its top edge, 9mm (⅜ in.) thick at its bottom edge.

The next step is to measure the exact length of the hoop. Wrap a piece of stout string around the container where the center of the hoop will lie. Add 8mm (⅝ in.). Transfer this length to the hoop blank, leaving room for the 80mm (3-in.) overlap at each end. The drawings at right detail the steps for first shaping the same side profile at each end of the hoop, and then shaping the female and male pattern in plan view.

Assemble and fit the longer upper hoop first. Ladle boiling

Preliminary shaping of hoop ends

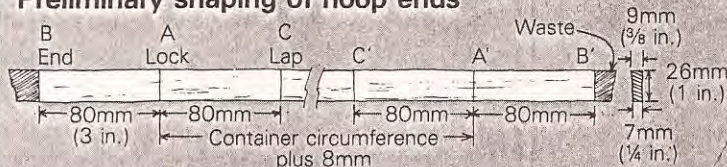

1. Lay out both ends of hoop, penciling lines on inside face.



2. Saw off waste ends. Kerf inside face at A and A', leaving 4mm (⅛-in.) thickness at bottom, 3½mm (⅛-in.) thickness at top.



3. Drawknife a concave surface from C to A (and from C' to A'). Drawknife a slight taper, about 3mm (⅛ in.), on the outside face of each end.

4. With a hollowing drawknife, relieve the inside face of hoop from A to A', so that only the corners of the hoop will contact the staves.



5. Drawknife a concave surface on the inside face of each end.

Cutting female end

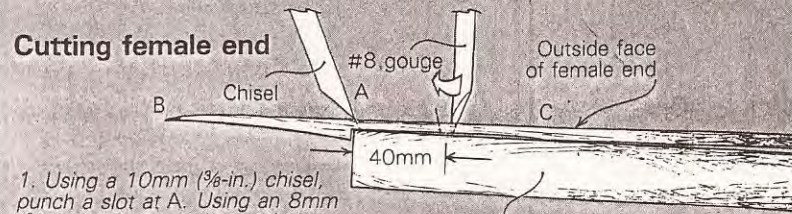

1. Using a 10mm (⅜-in.) chisel, punch a slot at A. Using an 8mm (⅝-in.) #8 gouge, bore a hole centered 40mm (1½ in.) from the slot. Rotate the gouge while pressing down.

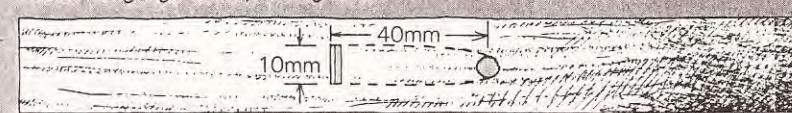

2. Knife a narrow opening from gouge hole to chisel slot.

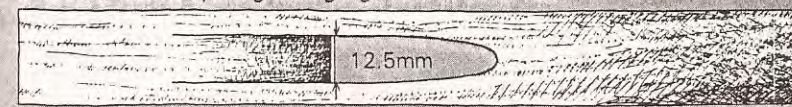

3. Widen the opening to 12.5mm (½ in.) at slot. Knife and chisel a flat, about 40mm long, that tapers into the slot.

Cutting male end

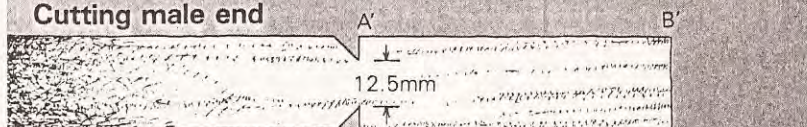

1. Whittle a piece of scrap, to scribe the width of the female slot on to the male end, centering it on the outside face at A'. Knife a V-cut from each edge to the scribe marks.

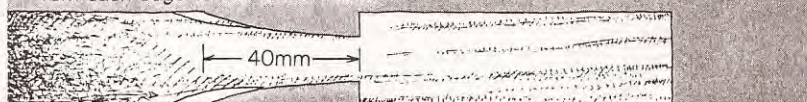

2. Knife a concave notch on each edge, about 40mm (1½ in.) long. Knife small chamfers to relieve the outside face where it can split when the ends are twisted together.

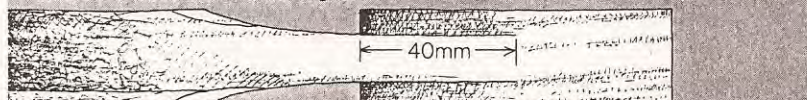

3. Knife and chisel two tapered flats, about 40mm long. Drawknife a narrow bevel along the lower edge of the hoop, for a lighter appearance. Fair the bevel out just before reaching the female end.

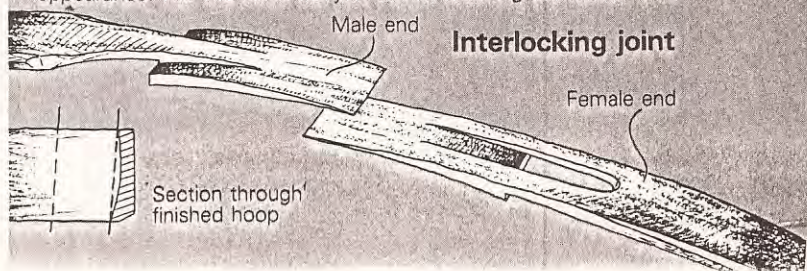

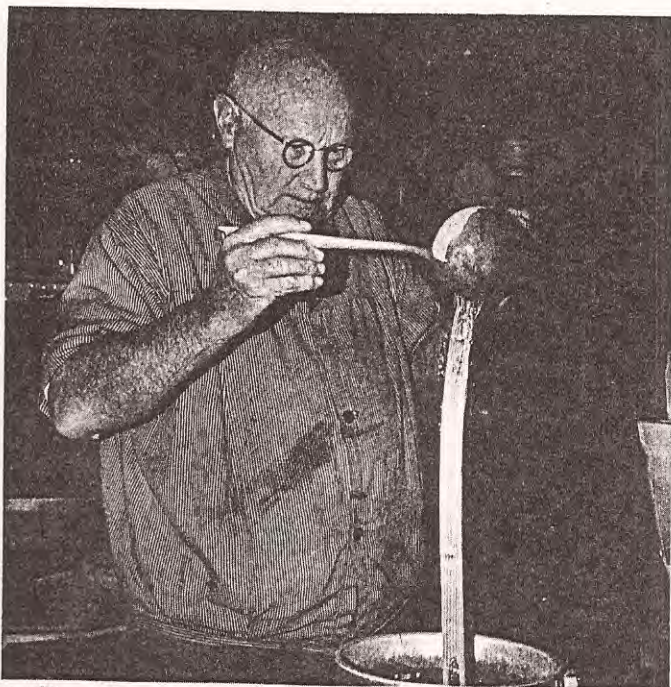

Ladling hot water over the hoop blank, above, limbers it for bending. The blank must be twisted, below, in order to fit one end through the other.

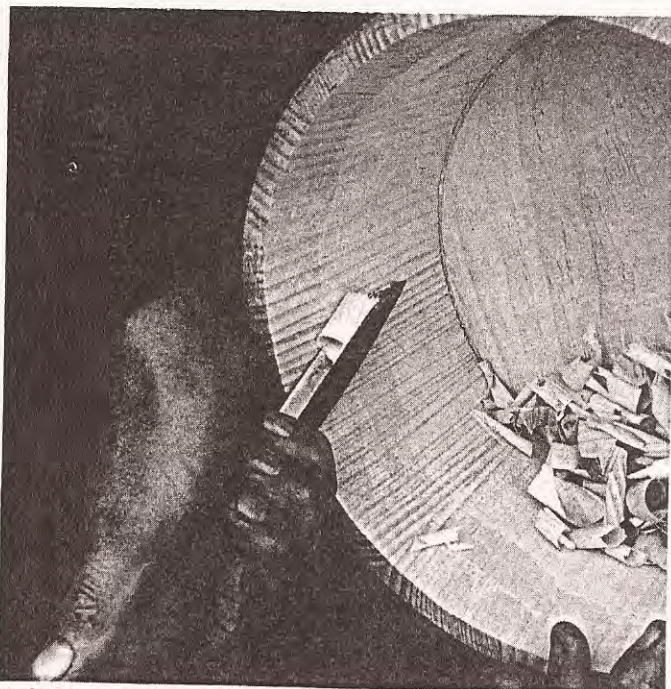
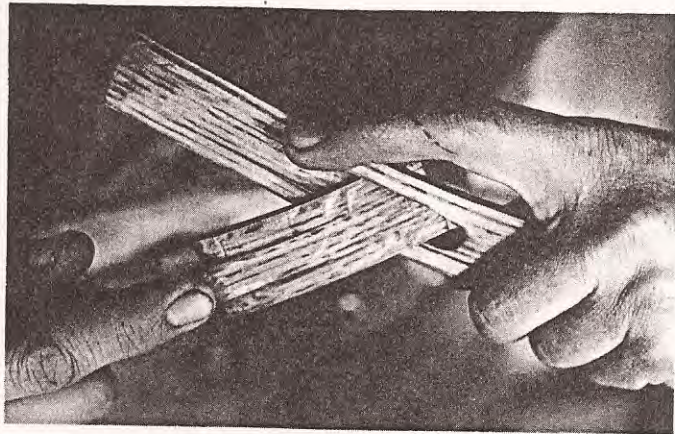

A knife sizes the rim line by beveling the waste away. Both the inside and the outside of the container will be thinned to meet these top and bottom rim lines.

water over the hoop for about one minute. Limber the hoop by flexing it. Limber the joint ends by inserting them in a vise opened about 10mm ($\frac{3}{8}$ in.); bend toward the interior face. Reheat the hoop by ladling more boiling water. Bend the hoop into a circle and twist the ends to insert the tab through the outside face of the slot. Any small splits should be immediately pared off with a knife so they don't run into the hoop.

With your container upside down on the bench, fit the hoop. Drive it into place by hammering on a small hardwood block. The hoop should become tight 25mm to 30mm (about an inch) from the upper rim. If the hoop is too tight (short), remove it from the container, and with the joint still assembled, saw 2mm to 3mm (up to $\frac{1}{8}$ in.) from one of the locking edges of the tab. An alternative is to thin the overlapping section by paring the inside faces with a knife. If the hoop is loose (too long), add a thin spacer between the male and female locking edges.

Now heat, limber and lock the lower hoop. Fit it so that the bottom of the hoop is flush with the bottom of the container. With a knife, trim the edges of the overlapping ends. Nail or peg both hoops in place. For pegs, drill 3mm ($\frac{1}{8}$ -in.) diameter holes through the hoops and into, but not through, the staves. Locate one peg on each side of the lock joint, plus two evenly spaced pegs on the opposite side of the hoop. Nails are generally brass with round heads.

After the wooden hoops have been fitted, the inside face of the rims can be dressed with a knife for a lighter, more finished look. Take long, smooth slices, beveling them about 65mm ($2\frac{1}{2}$ in.) from the top rim. The final thickness at the rim should be 8mm ($\frac{5}{16}$ in.). Make a similar bevel around the interior of the bottom rim.

A handle is optional. If you want one, make it from maple and secure it with wooden pegs. Note Kohler's clever arrangement in the photo on p. 73: the two extra-long staves are relieved, so the handle moves freely and doesn't bind against the rim. This photo also shows how the sides of a bucket are sometimes sculpted. While the effect is decorative, the purpose is really practical—it allows the bucket to be made more tapered, while still using a basically circular hoop of minimum inside taper. Kohler begins such a bucket with thicker, more tapered staves, gluing up the bucket as usual. Where the top of each of the two wooden hoops will be, he makes a sawcut about 3mm ($\frac{1}{8}$ in.) deep. With a skew chisel, he carves flat the area where each hoop will land. Above the area for the top hoop, he drawknives the outside of the bucket concave. Above the area for the bottom hoop, he drawknives the bucket convex. He then fits the wooden hoops as usual.

For farm use, staved containers are not given any surface treatment. The hoops of bowls and buckets sold as gifts or prizes are often chip-carved, and the whole is given a coat of quick-dry semigloss lacquer. Lacquered ware is easy to keep clean, but it is decorative, never used on the farm. Under continuous wetting and drying, it would soon deteriorate. □

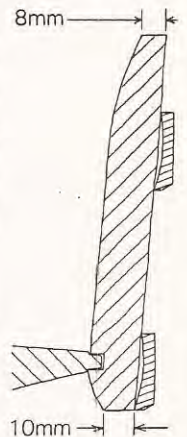

Drew Langsner will be teaching a week-long course in cooperage this summer. For details and information on this and other course offerings, write Country Workshops, Rt. 3, Box 262, Marshall, N.C. 28753. Photos by the author.